

# Yale Load King LTP2, LTG2 Army Type Trolley Hoist

Capacity range: 1/4 – 12 ton



Same quality and performance as the Load King LH2 in a compact, low headroom integral trolley mount. Ideal for applications requiring a moveable hoist including:

- Rugged steel loadbars connected directly to hoist frame
- Reduced headroom., side clearances and end approach for easy maneuvering of heavy loads in tight places
- Standard Load Limiter automatic overload protection
- Plain and geared trolley mounts in capacities from 1/4 to 12 tons
- Universal tread trolley wheels for operation on sloped or flat flanged beams
- Standard hand chain drop 2 feet less than lift (example: 8 foot lift hoist has 6 foot hand chain drop)
- Chain containers, zinc-plated load and hand chain, aluminum unwelded hand chain, Latchlok hooks, bronze hooks, bullard hooks, larger beam trolleys, trolley guards, and units without Load Limiter optional, depending on capacity
- Lifetime warranty
- Metric rated
- Made in U.S.A.

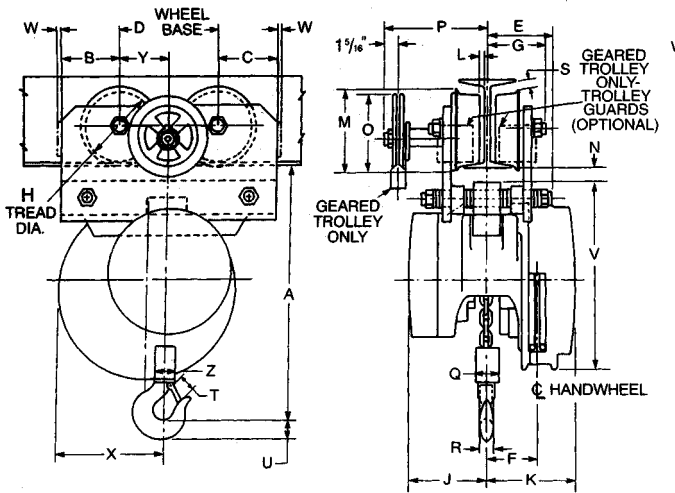

1/4 – 6 Ton

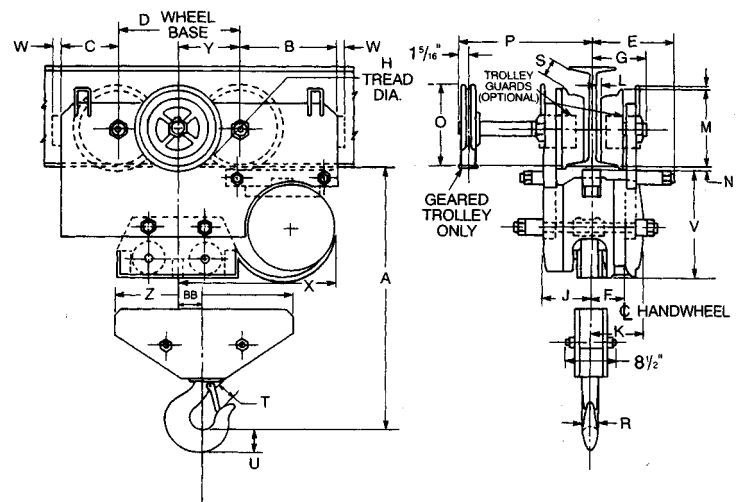

8 – 12 Ton

## Specifications

Rated Capacity* (Tons)	Product Code		Standard Lift (ft.)	Reeving	American Standard depth (in.) †	Beam Adjustment Ranges Flange Width (in.) †	Chain Pull to Lift Full Load	Chain Overhauled to Lift Load One Foot (ft.)	Minimum Headroom (in.)	Minimum Radius Curve (in.)	Shipping Weight (lbs.)	
	LTP2 Plain Trolley	LTG2 Geared Trolley									Plain Trolley	Geared Trolley
1/4	925-01400	925-01500	8	1	4-12 **	2 5/8-5 1/2	23	22 1/2	11 3/4	30	66	108
1/2	925-03400	925-03500	8	1	4-12 **	2 5/8-5 1/2	46	22 1/2	11 3/4	30	66	108
1	925-05400	925-05500	8	1	4-12 **	2 5/8-5 1/2	69	30	11 3/4	30	78	130
1 1/2	925-06400	925-06500	8	1	6-15	3 3/8-5 5/8	80	40 1/2	15 5/16	30	136	164
2	925-07400	925-07500	8	1	6-15	3 3/8-5 5/8	83	52	15 5/16	30	136	164
3	925-09400	925-09500	8	2	7-15	3 3/8-5 5/8	85	81	8 7/8	48	182	230
4	925-11400	925-11500	8	2	7-15	3 3/8-5 5/8	87	104	18 7/8	48	182	230
5	925-13400	925-13500	8	3	8-18	4-6 1/4	74	156	23 1/2	60	268	300
6	925-14400	925-14500	8	3	8-18	4-6 1/4	89	156	24	60	273	305
8	925-16400	925-16500	8	4	12-24	5-8	91	208	28 1/4	72	506	589
10	925-17400	925-17500	8	5	12-24	5-8	93	260	28 1/4	72	513	596
12	925-18400	925-18500	8	6	12-24	5 1/2-8	95	312	30 3/8	96	1050	1130

\*\*For 1/4 through 1 ton geared trolleys - minimum beam size S6 x 12.5 (3 3/8 flange width)

† Universal tread trackwheels designed to operate on either sloped or flat flange beams, rails, or tracks

## Clearance Dimensions (in.)

Dimension	Rated Capacity* (tons)															
	1/4, 1/2, & 1		1 1/2 & 2		3 & 4		5		6		8		10		12	
	Plain	Geared	Plain	Geared	Plain	Geared	Plain	Geared	Plain	Geared	Plain	Geared	Plain	Geared	Plain	Geared
A	11 3/4	11 13/16	15 5/16	15 5/16	18 7/8	18 7/8	23 1/2	23 1/2	24	24	28 1/4	28 1/4	28 1/4	28 1/4	30 3/8	30 3/8
B	4 3/16	4 3/8	3 11/16	3 11/16	5 3/4	5 3/4	6 1/2	6 1/2	6 1/2	6 1/2	8 15/16	8 15/16	8 15/16	8 15/16	10 7/8	10 7/8
C	2 9/16	2 9/16	3 11/16	3 11/16	3 7/16	3 7/16	3 3/4	3 3/4	3 3/4	3 3/4	5 1/4	5 1/4	5 1/4	5 1/4	7 3/16	7 3/16
D	6	6	6	6	6 7/8	6 7/8	7 3/4	7 3/4	7 3/4	7 3/4	11	11	11	11	11	11
E	4 1/2	4 15/16	5	5	5 7/16	5 7/16	6 1/8	6 1/8	6 1/8	6 1/8	7 1/4	7 1/4	7 1/4	7 1/4	7 1/4	7 1/4
F	2 1/16	2 1/16	3 3/8	3 3/8	3	3	2 11/16	2 11/16	2 11/16	2 11/16	3	3	3	3	3	3
G	3	3 3/4	3 5/8	3 3/4	4 5/16	4 5/16	4 15/16	4 15/16	4 15/16	4 15/16	5 9/16	5 9/16	5 9/16	5 9/16	5 13/16	5 13/16
H	3 1/8	4	4 3/4	4	5	5	6	6	6	6	8	8	8	8	8	8
J	3 3/4	3 3/4	4 13/16	4 13/16	4 13/16	4 13/16	5	5	5	5	4 13/16	4 13/16	4 13/16	4 13/16	4 13/16	4 13/16
K	4 1/8	4 1/8	5 1/16	5 1/16	5 1/16	5 1/16	4 7/8	4 7/8	4 7/8	4 7/8	5 1/16	5 1/16	5 1/16	5 1/16	5 1/16	5 1/16
L	5/16	5/16	1/2	5/16	1/4	1/4	3/8	3/8	3/8	3/8	1/2	1/2	1/2	1/2	1 1/16	1 1/16
M	4	4 3/4	5 5/16	4 3/4	5 7/8	5 7/8	7	7	7	7	9 7/16	9 7/16	9 7/16	9 7/16	9 1/2	9 1/2
N	1/2	9/16	9/16	9/16	1 1/16	1 1/16	1 1/16	1 1/16	1 1/16	1 1/16	1/2	1/2	1/2	1/2	7/16	7/16
O	---	5 9/16	---	5 9/16	6 1/8	6 1/8	6 3/4	6 3/4	6 3/4	6 3/4	7 7/16	7 7/16	7 7/16	7 7/16	7 3/16	7 3/16
P	---	10	---	10	8 15/16	8 15/16	10 7/16	10 7/16	10 7/16	10 7/16	11 7/16	11 7/16	11 7/16	11 7/16	11 11/16	11 11/16
Q	2	2	2 1/2	2 1/2	3 7/8	3 7/8	4	4	4	4	11 15/16	11 15/16	---	---	---	---
R	1 1/16	1 1/16	1 1/8	1 1/8	1 1/4	1 1/4	1 1/4	1 1/4	1 3/8	1 3/8	1 3/8	1 3/8	1 3/8	1 3/8	2 3/8	2 3/8
S	1/16	15/16	3/16	15/16	15/16	15/16	3/4	3/4	3/4	3/4	2 3/16	2 3/16	2 3/16	2 3/16	5 1/16	5 1/16
T	1	1	1 3/8	1 3/8	1 1/8	1 1/8	1 5/8	1 5/8	1 3/4	1 3/4	2 1/16	2 1/16	2 1/16	2 1/16	3	3
U	7/8	7/8	1 1/8	1 1/8	1 11/16	1 11/16	1 11/16	1 11/16	1 7/8	1 7/8	2 9/16	2 9/16	2 9/16	2 9/16	3	3
V	10 1/8	10 1/8	11 3/8	11 3/8	11 3/8	11 3/8	11 3/8	11 3/8	11 3/8	11 3/8	11 5/8	11 5/8	11 5/8	11 5/8	11 5/8	11 5/8
W	1/4	3/8	3/8	3/8	1/2	1/2	5/8	5/8	5/8	5/8	5/8	5/8	5/8	5/8	5/8	5/8
X	7 3/16	7 3/16	6 11/16	6 11/16	8 15/16	8 15/16	10 5/16	10 5/16	10 5/16	10 5/16	14 7/16	14 7/16	14 7/16	14 7/16	16 3/8	16 3/8
Y	3	3	3	3	3 7/16	3 7/16	3 7/8	3 7/8	3 7/8	3 7/8	5 1/2	5 1/2	5 1/2	5 1/2	5 1/2	5 1/2
Z	2	2	2 1/2	2 1/2	4 1/2	4 1/2	6 1/4	6 1/4	6 1/4	6 1/4	13 15/16	13 15/16	18 3/16	18 3/16	21 11/16	21 11/16
AA	---	---	---	---	---	---	---	---	---	---	3/8	3/8	3/8	3/8	3/8	3/8
BB	---	---	---	---	---	---	---	---	---	---	1 15/16	1 15/16	0	0	0	0

Note: Dimensions are based on minimum beam and may vary with larger beams.